

Panelmonterat uttag med TwinCONTACT

Art.nr 1790



- skruvfria fjäderplintar
- lämplig för genomdragning
- rak

Tekniska data

Ampere	32 A
Poler	4 p
Volt	230 V
Klockposition	9 h
Hertz	50-60 Hz
Anslutningsteknologi	skruvlös – TwinCONTACT
Kontakt	standard
Skyddstyp	IP44
Fläns	75x75 mm
Fästhål	60x60 mm
Vikt	196 g
Intyg om överensstämmelse	VDE, EAC, CQC

Mått

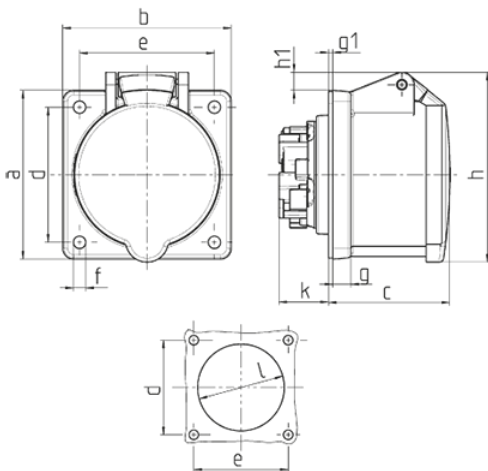

Drawing 1 MB 464	Amp. Poles	16			32		
		3	4	5	3	4	5
Dim. in mm	a	75	75	75	75	75	75
	b	75	75	75	75	75	75
	c	53	53	54	64	64	64
	d	60	60	60	60	60	60
	e	60	60	60	60	60	60
	f	5.5	5.5	5.5	5.5	5.5	5.5
	g.	8	8	8	8	8	8
	g.1	2	2	2	2	2	2
	h	75	80	85	89	89	95
	h1		5	8	10	10	12
	k	22	22	22	28	28	28
	l	43	52	57	60	60	64
	Terminal for cond. cross section (mm ²) min.-max.	1.5	1.5	1.5	2.5	2.5	2.5
		-4	-4	-4	-6	-6	-6